



Barcode: 5060452082035

forma-stor coshh™

Product code: FR300-C

- » Quick-assembly modular storage for hazardous substances.
- » Heavy-duty open steel floor, allowing spillages to drain into the sump.
- » This unit arrives flat packed or assembled at additional cost.



Product features



2x 5-lever deadlock



Forklift pockets



Crane lifting eyes



COSHH compliant



Sump capacity 680L



Collapsible



Stackable



Fire resistant

Product specifications

Weight	553kg
Colour	Traffic red: RAL 3020
Suitable for	Outdoor storage of flammables or chemicals
Finished coating	Galvanised and powder coated
Material & thickness	1mm and 2mm steel
Quantity of keys	3 keys
How are castors fitted?	Not applicable
Other sizes available	3 other sizes
Ventilation	Yes
Qty of shelves as standard	0 shelves

Dimensions

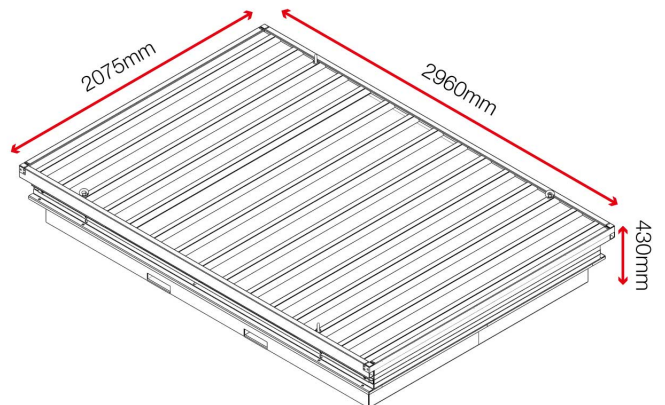

Optional extras - Contact Armorgard to find out more



Shelf FRS2



BlokkaBar FRBL2

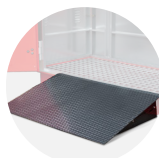

Ramp FRR4

